

Anbau C1
Art. Nr. 9909600
1/5

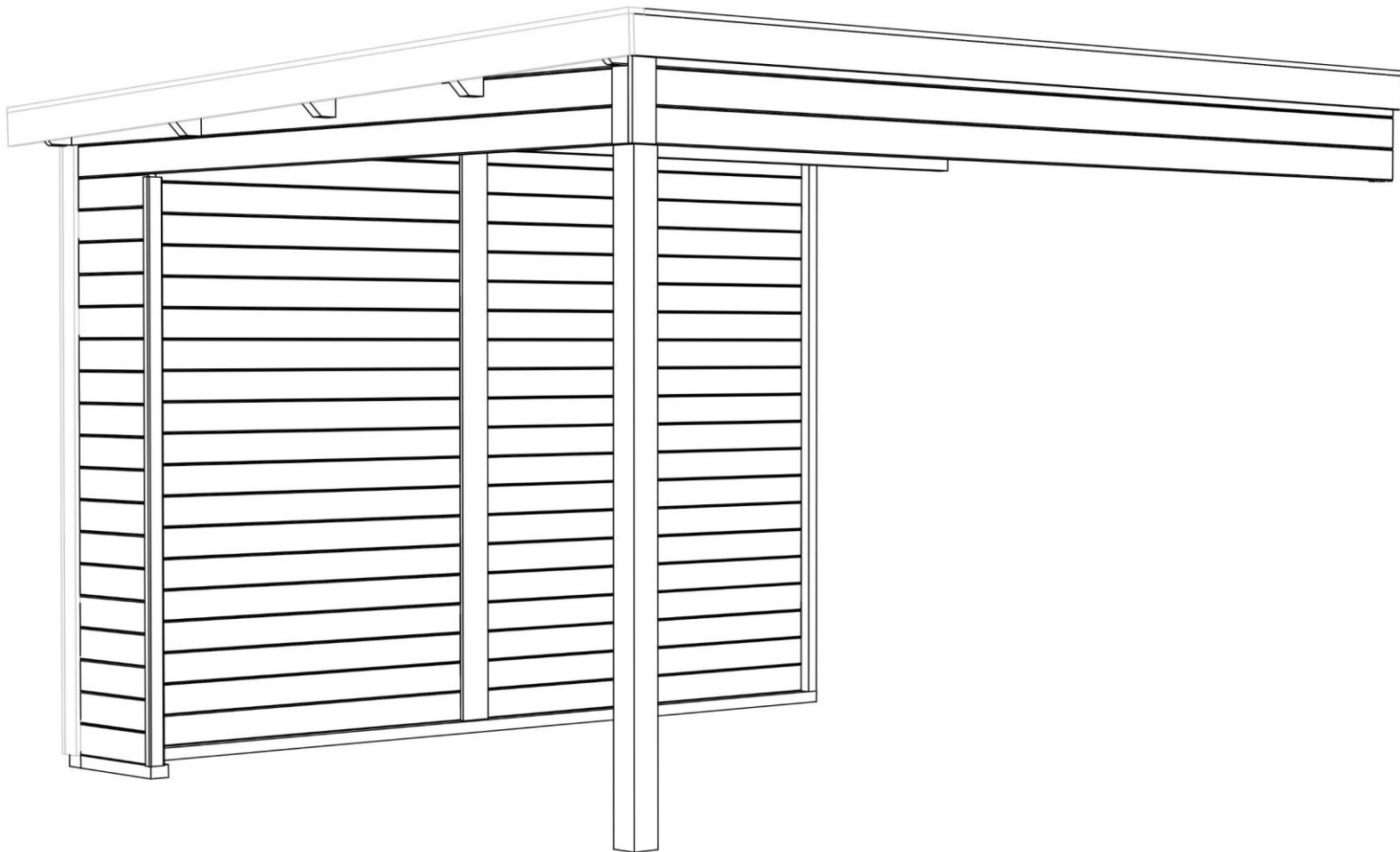

Art. Nr. 9909600

Groundplan - Grundplan - Plan de masse - Planimetria -
Plattegrond - Põhiplaan

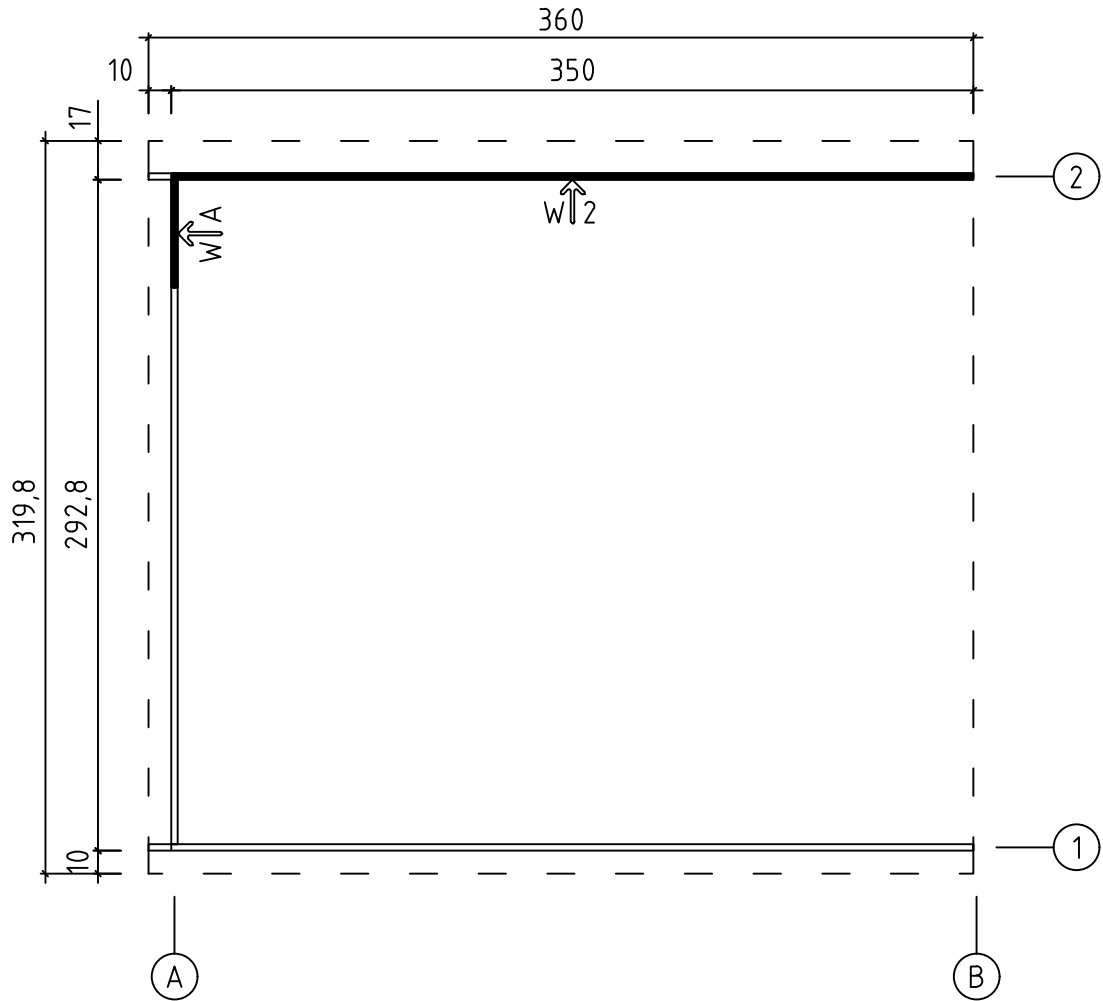

Foundation - Fundament - Fondation - Fondamenta -
Fundering - Immutatud alusraam

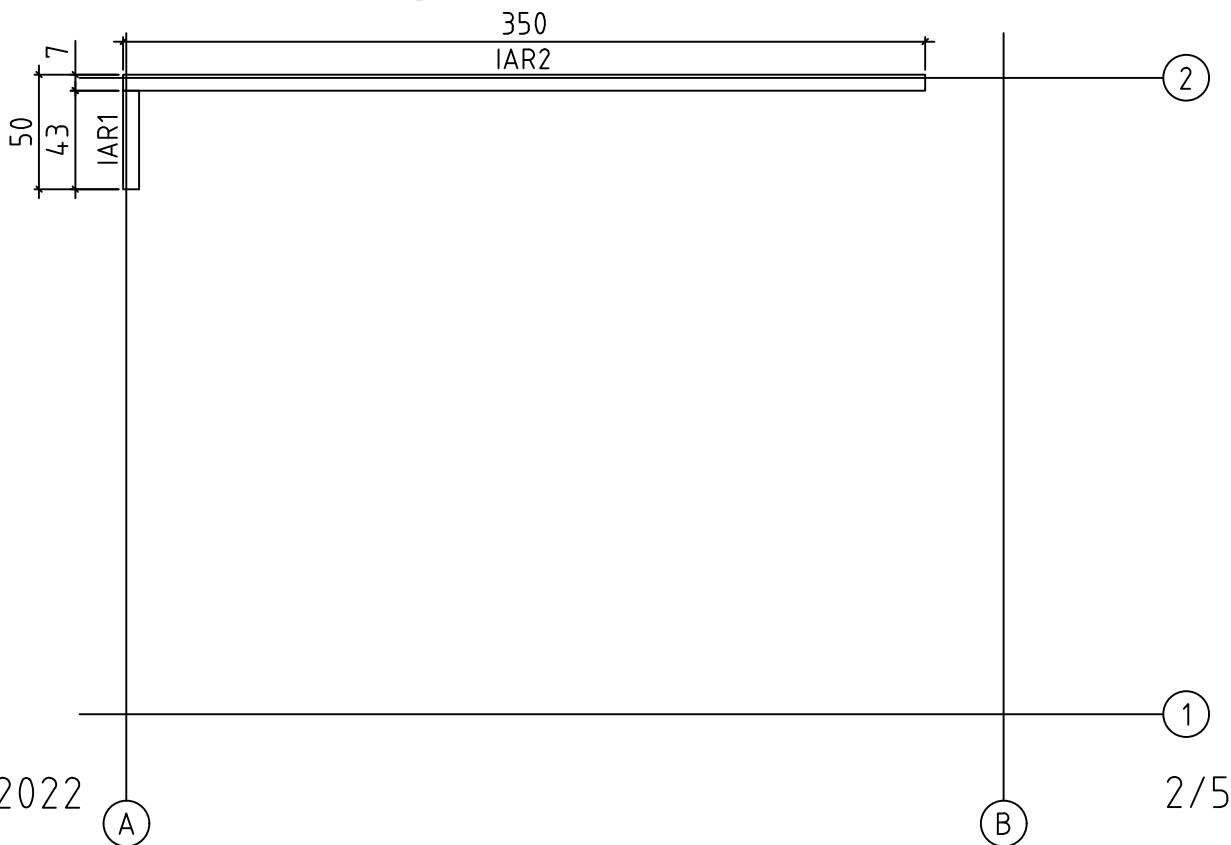

16.12.2022





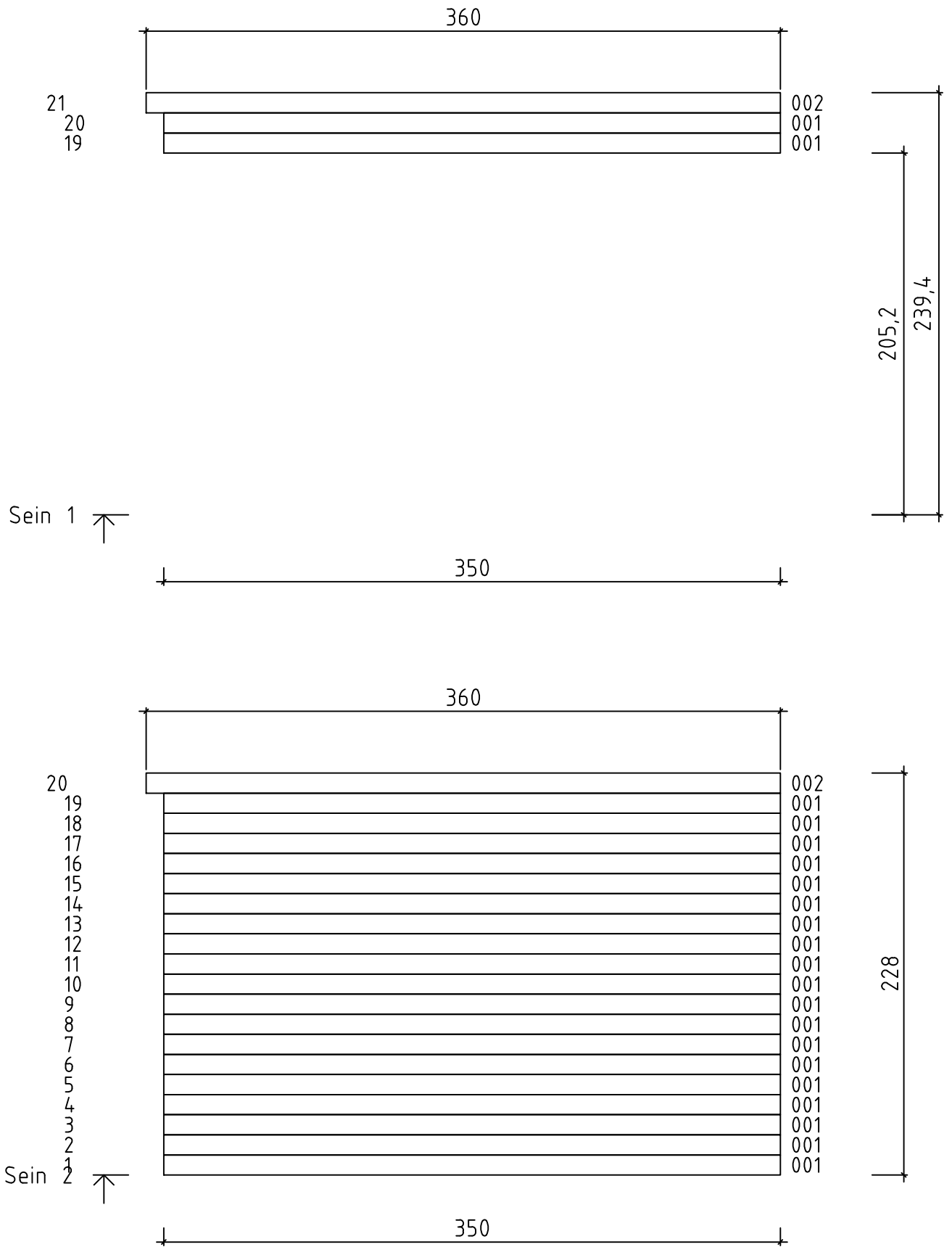



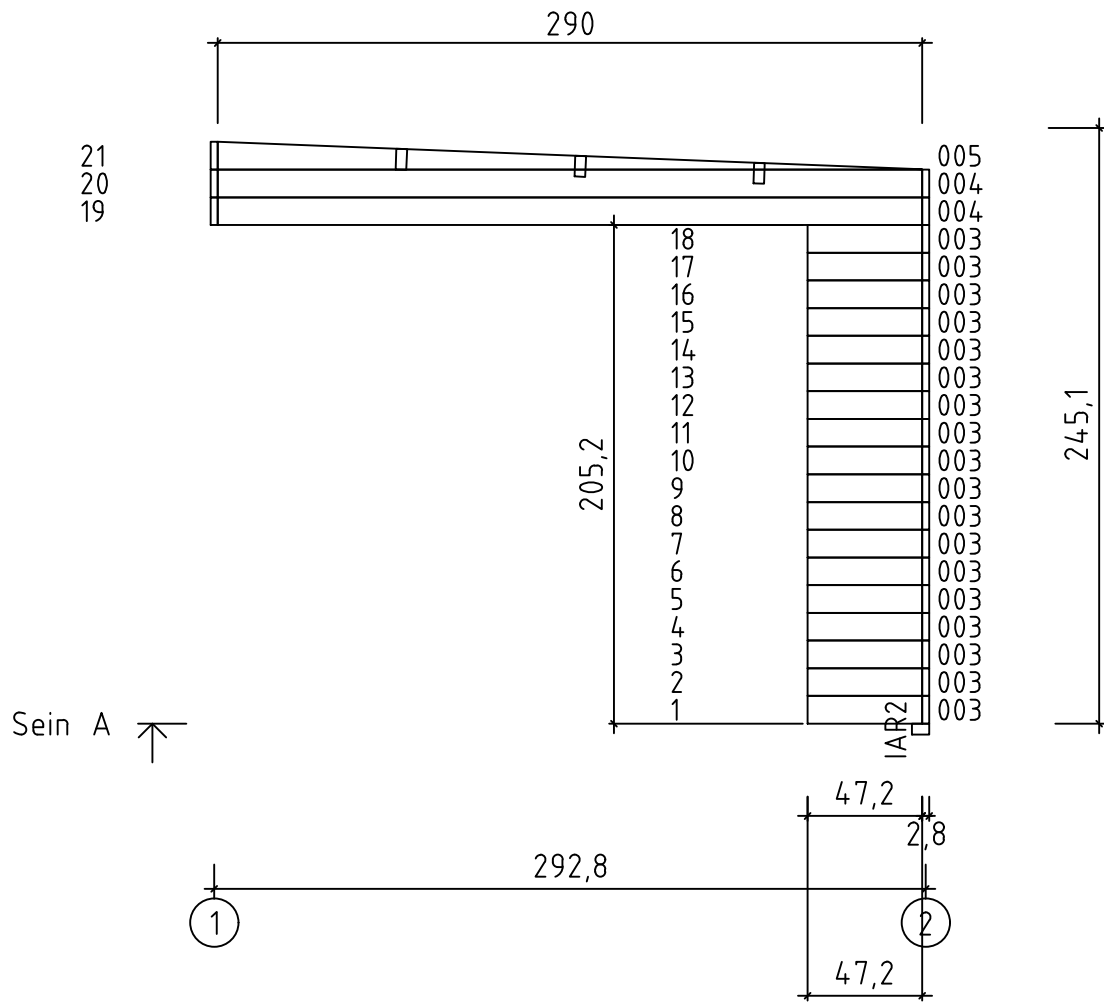

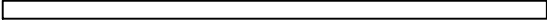
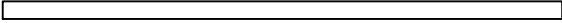

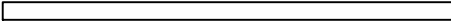
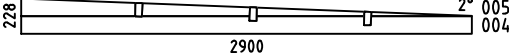
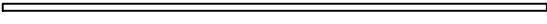
2/5

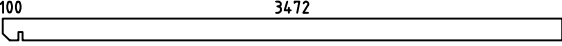
Art. Nr. 9909600

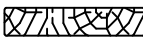
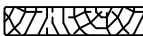
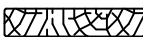

Art. Nr. 9909600

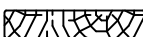
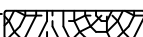

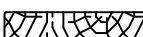
Pos	16.12.2022 Piece list - Stückliste - Liste des pièces - Elementi - Stuklijst - Tükitalabel Art. Nr. 9909600 5/5	Arv	Profiil (mm)	Pikkus (mm)
001 6012		21	28x114	3500
002		2	28x114	3600
003		18	28x114	472
004 18105		1	28x114	2900
WA-1		1		
IAR2 1645	Foundation - Fundament - Fondation - Fondamenta - Fundering - Immutatud alusraam 	1	70x45	3500
IAR1	Foundation - Fundament - Fondation - Fondamenta - Fundering - Immutatud alusraam 	1	70x45	430
A-PR1	Roof beam - Dachbalken - Panne de toit - Perlina del tetto - Gordingen / dakbalk - Pärilin 	3	44x140	3600
6900	Roof boards - Dachbretter - Voliges - Perlina per tetto - Dakhout - Katuselaud 	40+1	90x15	3200
11010	Roofing felt fillet - Dachpappenleiste - Baguette de fixation du feutre bitumeux - Asse per fissaggio guaina bituminosa - Afdeklijst asfaltpapier - Katusepapiiist 	1	18x58	3500
	Corner stud - Eckpfosten - Poteaux d'angle pour fixation des madriers - Perno angolare - Hoek staander (kolom) - Nurgapost 	1	44x44	338
31654	Corner stud - Eckpfosten - Poteaux d'angle pour fixation des madriers - Perno angolare - Hoek staander (kolom) - Nurgapost 	2	44x44	2260
	Corner fillet - Deckleiste - Profils de finition angles a l'exterieur - Massello d'angolo - (hoek)lijst - Nurgaliist 	1	18x70	340
	Corner fillet - Deckleiste - Profils de finition angles a l'exterieur - Massello d'angolo - (hoek)lijst - Nurgaliist 	1	18x90	340
30191	Corner fillet - Deckleiste - Profils de finition angles a l'exterieur - Massello d'angolo - (hoek)lijst - Nurgaliist 	1	18x90	2280
	Corner stud - Eckpfosten - Poteaux d'angle pour fixation des madriers - Perno angolare - Hoek staander (kolom) - Nurgapost 	1	90x90	2400
	Gable moulding - Giebelleiste - Planche de rive - Finitura per frontale e retro del tetto - Gevelliist - Viilulaud 	1	18x120	3500
TB-1 1214	Fascia board - Traufbrett - Bandeau de toit - Finitura lati tetto - Gevelliist - Räästalaud 	1	18x90	3500
DRV-1 1215	Roof edge reinforcement - Dachrandverstärkung - Corniere de renfort de bord de toit - Rinforzo x tetto - Dakrand versterking - Räästatugevdus 	2	28x34	3500
35094	U-profile - U-profils - Profile u - Profilo ad u - U-profiel - U-profiil 	1	28x58	2017
	Railing strip - Begrenzungsleiste - Rembarde - Sbarra - Afscheidingslijst - Piirdelaud 	1	18x120	2270